

PLANNING COMMISSION STAFF REPORT

**Harmons Emigration Market
Planned Development
Petition No. PLNPCM2010-00672
1706 E 1300 South
December 8, 2010**



Planning and Zoning Division
Department of Community and
Economic Development

Applicant:

Harmons Grocery

Staff:

Elizabeth Reining
elizabeth.reining@slcgov.com
801-535-6313

Tax ID:

16-09-457-001

Current Zone:

Neighborhood Commercial (CN)

Master Plan:

East Bench Community

Council District:

District 6, JT Martin

Lot Size:

0.63 acres

Current Use:

Vacant market and parking lot

Applicable Land Use Regulations:

21A.55

Notification

- Notice mailed on November 23, 2010
- Sign posted on November 23, 2010
- Agenda posted on the Planning Division and Utah Public Meeting Notice websites November 23, 2010

Attachments:

- A. Photographs
- B. Application Narrative
- C. Proposed Site Plans

Request

Harmons Grocery requests a planned development at 1706 E. 1300 South to reopen the former Emigration Market. As part of reopening the grocery store, Harmons plans to renovate the building and site. Harmons is applying for a planned development because it wants to keep and expand two current non-complying structures, build a non-complying fence and construct two non-complying signs.

Staff Recommendation

Based on the findings listed in the staff report, it is the Planning Staff's opinion that the project generally meets the applicable standards for a planned development and therefore recommends the Planning Commission approve a request for a planned development with the following conditions:

- The applicant meet all the department comments as outlined in this staff report.
- Transparent glass is used along 1700 East beginning 3 feet above the sidewalk elevation.

VICINITY MAP

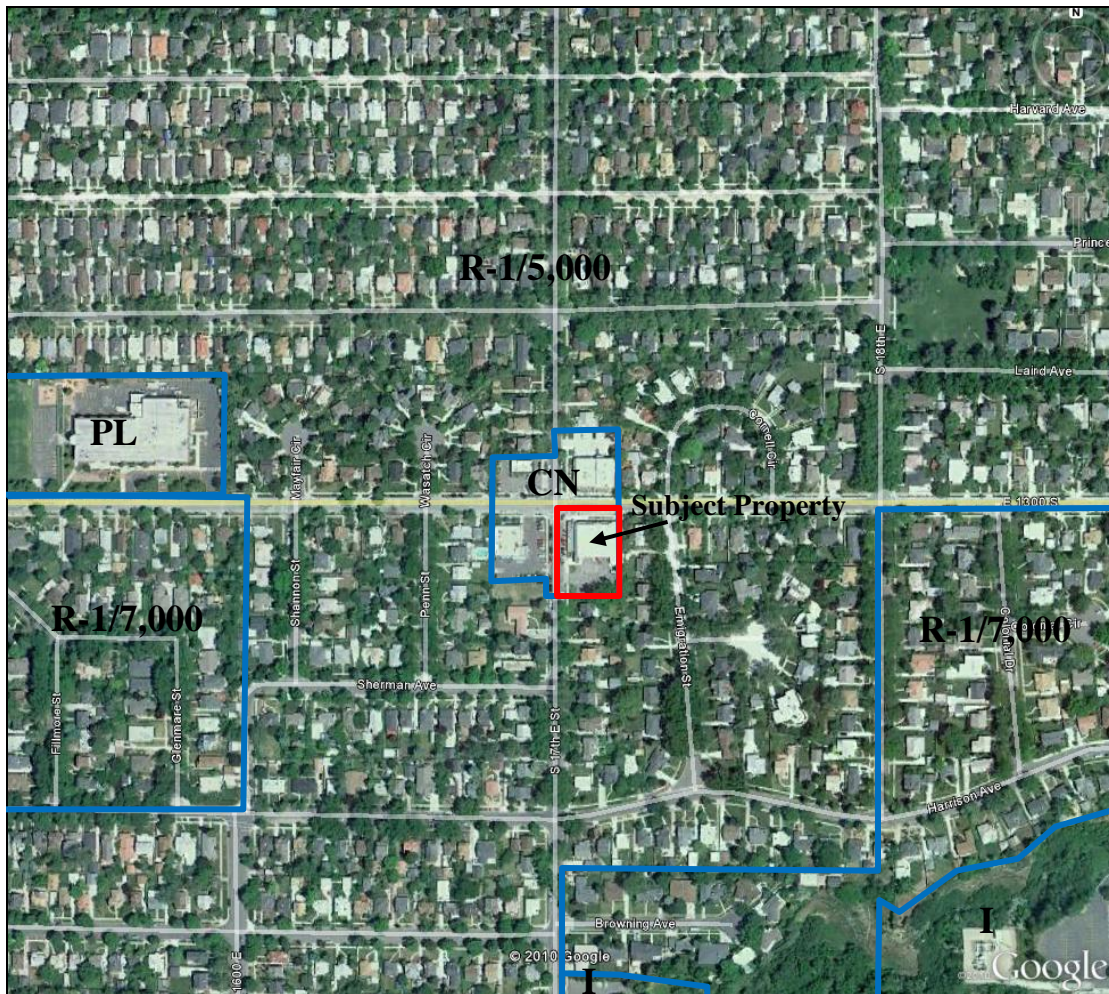

Background

Project Description

Emigration Market closed on April 3, 2010 after 68 years of operation. In July, Harmons purchased the site with plans to reopen the market as a full service grocery store. As part of plans to reopen the store, Harmons wants to keep and expand two current non-complying structures, build a non-complying fence and construct two non-complying signs.

Currently an enclosed addition to Emigration Market sits along 1700 East. The previous tenants used the space for a dining area. The addition was originally permitted as an outdoor seating area. The enclosure of the space was not permitted by the City. The addition sits within the required 15 foot front yard (21A.26.020.F.1) and encroaches two feet into the City's right of way. Harmons plans to demolish this current addition and build a new addition that will continue to encroach into the front yard setback and will be built to the property line. The new addition will be incorporated into the store and used as the deli/bakery work area. Harmons proposes to replace the glass windows along 1700 East with panels that transition from translucent glass to clear glazing at 42" above the finished floor grade (See Appendix A: Proposed Site Plans). Due to elevation changes along

1700 East the transparent transition would occur 4' 6" to 5' above the sidewalk. Staff supports the new addition being placed in the required front yard setback but does not support the amount of translucent glazing proposed. Staff feels that transparent glass along 1700 East would increase the building's pedestrian orientation. The CN (Neighborhood Commercial) zoning district standards states "first floor elevation facing a street of all new buildings or buildings in which the property owner is modifying the size of windows on the front façade, shall not have less than 40% glass surfaces. All first floor glass shall be non-reflective (21A.26.020.I)." Also, planned developments in the CN (Neighborhood Commercial) zoning district are supposed to meet the general guideline: "The facades shall maintain detailing and glass in sufficient quantities to facilitate pedestrian interest and interaction (21A.55.090)."

Currently along the eastern property line between Emigration Market and single family residences sits a non-complying walk-in cooler within the required rear yard setback of ten feet (21A.26.020.F.3). Harmons wishes to replace that cooler with three larger walk-in coolers that will continue to sit along the eastern property line within the rear yard setback. Harmons wants to place these coolers along the eastern property line to increase the sales area inside the grocery store. The gross floor area of Emigration Market will increase by 835 square feet with Harmons' renovations.

Currently, multiple wooden fences of various heights and designs sit along the eastern and southern property lines separating Emigration Market from surrounding single family residences. The zoning ordinance requires a solid fence to not exceed six feet in height (21A.40.120.E). Harmons is requesting a wall constructed of stamped or textured concrete panels and brick piers of varying heights. The varying heights, ranging from 9'6" to 4', are at the request of the specific residents on the other side of the property line. The two property owners that border the coolers along the eastern property line would prefer a wall that hides the coolers (9'6"), a third property owner on the eastern property line would prefer a wall height to match the height of the existing fence (5'7"). The wall along the southern property line will have a height of 6' 6" until it meets the front building line of the neighboring single family residence. From there the wall will step down to 4'. The transition between fence heights will occur at the brick pillars. The exterior fencing will have a stepped look. Harmons will also place landscaping along the neighbors side of the wall to further mitigate the wall's impact.

Emigration Market currently has two non-complying signs, the "Emigration Market" roof signs along 1300 South and 1700 East. Roof signs are not allowed in the CN (Neighborhood Commercial) zoning district and flat signs cannot exceed 2 feet above the roof line (21A.46). The signs each peak at 5 feet above the roof along 1300 South and 1700 East. Harmons plans to refurbish and keep these signs at their current locations. Harmons also wants to add two new non-complying signs at the main entrances to the store. The new aluminum "Harmons" signs will sit directly above the main door vestibules facing the parking lot and 1700 East. The proposed new signs will not exceed the height of the building proper. The "Harmons" sign facing the parking lot will be 16" and the "Harmons" sign facing the pedestrian entrance off 1700 East will be 12". Each will be above the roof line of the entrance vestibules. Neither "Harmons" sign will have internal illumination. Each will have external illumination at the base. Harmons is including these signs as part of the planned development because the CN (Neighborhood Commercial) zoning district only allows one flat sign per street frontage. The sign off 1700 East would be an addition to the "Emigration Market" sign on 1700 East. The "Harmons" sign facing the parking lot is on the south side of the building, which does not have street frontage.

Harmons will offer 24 off street parking spaces on site. The zoning ordinance requires 28 spaces (21A.44.060.F). Harmons is seeking a partial parking exemption from the required 28 parking spaces because it is including pedestrian friendly features in the grocery store's development. The zoning ordinance does allow a partial parking exemption to 23 parking spaces if a business provides features that entice patrons to use alternative modes of transportation (21A.44.020.M). Harmons plans to place four bicycle racks and two pet waiting areas along 1700 East. Harmons will also reimburse employees public transportation costs and

encourage them to use alternative travel methods to travel to and from work. The Transportation Department has approved the partial required off-street parking reduction.

Currently, the site has non-complying off street parking because parking is not allowed in the required front yard setback in the CN (Neighborhood Commercial) zoning district and the front yard setback is to be maintained as a landscaped yard (21A.26.020.F). Since the parking lot existed prior to 1995 and no spaces will be removed, Harmons may reconstruct the parking lot as is as part of their renovations (21A.44.010.I).

Harmons will provide indoor and outdoor seating as part of Emigration Market's reopening but full-serve food service will no longer be available. Harmons will provide 27 seats with tables at the store's entrance along 1700 East and 28 seats with tables outside along 1300 South.

Harmons will meet all other zoning and city regulations in its reopening of Emigration Market.

Master Plan

The subject parcel is found in the East Bench Community Master Plan, adopted in 1987. The parcel's future land use designation is the same as its current zoning, CN (Neighborhood Commercial). The East Bench Community Master Plan states that non-residential land uses within the East Bench community are primarily there to provide support to residential land uses. A neighborhood grocery store, such as Emigration Market, supports surrounding residential uses by allowing residents to shop within the community for essentials.

The East Bench Community Master Plan additionally states that new development "must be sensitive to neighborhood scale and design...compatibility with the immediate neighborhood is essential." The new Harmons Emigration Market will continue to be pedestrian friendly and inviting to the surrounding neighborhood with outdoor seating, bicycle racks and pet waiting areas. The intersection of 1300 South and 1700 East has small commercial development on all four corners. The reopening of a grocery store at that location will complement the existing pharmacy and two restaurants.

Comments

Public Comments

Harmons has met with both the Wasatch Hollow and Yalecrest Community Councils to discuss the project. Both generally support the project. The Wasatch Hollow Community Council's one concern was that the neighboring residences must be satisfied with the store's fencing. Harmons claims to have designed their fence with the neighbors input. The Yalecrest Community Council expressed minor concerns about parking. The inclusion of bike racks and pet waiting areas should promote more people to walk and bike to the store. Harmons met with the Yalecrest Community Council because the site borders the Yalecrest Community Council District.

City Department Comments

Copies of the application and site plan were sent to various city departments on October 25, 2010. Generally, departments were in support of the project but there were some concerns including the removal of glass along 1700 East for glazed panels, new refrigeration coolers along the property line next to residential properties, new proposed signage and needed sidewalk repair. If the applicant has revised the application in response to

comments or the comments have been otherwise answered, a note is added to the specific department comment. Staff feels that the comments not responded to should be a condition of approval.

Planning-

There are concerns that replacing the glass windows with glazed panels along 1700 East would reduce the pedestrian orientation of the building. The new “Harmons” roof signs do not comply with current zoning regulations. The application needs to be amended to include this signage.

Harmons has revised its application to show a transition from translucent glass to clear glazing at 42” above finished floor grade. Staff feels that the windows should be transparent glass or the transition should be lower. Staff feels that this condition should be included as part of the approval. The “Harmons” signs above the entrance vestibules have been included in the planned development application.

Public Utilities-

The property is currently served with water and sewer services. The water services consist of a one-inch lawn meter, a one-inch culinary water meter and a six-inch fire suppression line. All water services are in compliance and may be reused. There appear to be four sanitary sewer connections to the property. Any unused sewer connections should be killed at the property line. The termination of these laterals must be coordinated with the Public Utilities Contracts Office for proper record keeping and inspection. Note that this review does not constitute a review for any permits regarding Public Utilities.

This needs to be a condition of approval.

Zoning-

The building permit plan submittal must comply with all other zoning requirements not approved as part of this petition, including building signage. Roof signs are not permitted in this zone.

The “Harmons” signs above the entrance vestibules have been included in the planned development application.

Engineering-

This is a project to upgrade two existing commercial buildings and construct a perimeter fence. All of the required right-of-way exists, as do the required street improvements. On 1700 East, one section of sidewalk at the drive approach and the ‘apron’ in the drive approach are deteriorated such that they meet the criteria of APWA Std. Plan 291A for defective improvements and must be replaced as per APWA Std. Plan 225 and 231. There are also three panels of sidewalk along this frontage that have a raised edge, which create trip hazards which must be ground down to eliminate the hazards. On 1300 South, the pavers in the carriage walkway have sunken such that they are also a trip hazard and must be repaired to eliminate said hazard. All of this work must be done by a licensed, insured and bonded contractor who must first obtain a Public Way Permit from our office.

This needs to be a condition of approval.

Transportation-

The proposal is per city standards to request parking exemption from the 28 parking stalls required per the 2 stalls per 1,000 square feet gross building area of 13,684 square feet. To the 24 stalls to be provided on site by excluding 2,500 square feet or minus 5 stalls requiring only 23 stall per section 21A.44.020M-1 CN Zone -2 Amenities, by providing additional bike stalls (two required & four provided) along with two pet waiting areas, outdoor seating, and a reimbursement program for their employees to use public transportation, and encourage biking and walking.

Fire-

I did have comments regarding the exterior walls of the coolers and freezers as to the fire ratings since the walls are on the property line. Also to the trash enclosure since one wall is on the property line and the other two walls share the walls for the building and cooler. The first item is a building code issue and the second is a fire code issue.

Harmons has revised its plans to meet Fire's comments. The new wall on the eastern property line will be constructed as a two hour fire rated wall. The roof structure will also be two hour fire rated. The trash enclosure has been moved 10 feet away from the property line.

Analysis and Findings

Options

Options for the planned development application include approval, approval with conditions or denial of the request. If the request is denied, Harmons can open the Emigration Market but not externally renovate the structure and any external changes must comply with all applicable zoning regulations. If the request is approved, Harmons can expand the current Emigration Market.

Findings

It is the responsibility of the applicant to provide written and graphic evidence demonstrating compliance with the following standards:

- A. Planned Development Objectives:** The proposed planned development shall meet the purpose statement for a planned development (21A.55.010) and will achieve at least one of the objectives stated in said section.

Analysis: Harmons is applying for a planned development because it wants to keep and expand two current non-complying structures, build a non-complying fence and construct two non-complying signs. There is currently a non-complying structure in the front yard setback, a dining area from the prior establishment, and a non-complying structure in the back yard setback, a walk-in cooler. Harmons wants to replace the previous dining area addition with an addition that will be incorporated into the store. Harmons plans to replace the existing cooler with three new coolers in the same area, within the rear yard setback. Harmons would also like to construct an exterior fence that would be taller than normally allowed in the CN (Neighborhood Commercial) zoning district. The zoning district allows a six feet tall fence while Harmons would like to construct a fence that is up to 9'6" in some areas. The taller fence is in request to neighbors bordering the new coolers. Harmons would like to add "Harmons" signage to the store's entrance vestibules. Because Harmons wants to keep the "Emigration Market" sign on 1700 East and the "Harmons" signs will be above the vestibules' roof line, the proposed signs do not meet district regulations.

The purpose statement of planned developments (21A.55.010) states in part "a planned development will result in a more enhanced product than would be achievable through strict application of land use regulations, while enabling the development to be compatible and congruous with adjacent and nearby land developments." In the case of Harmons Emigration Market, staff feels that allowing the addition to be rebuilt to the property line in the required front yard setback and the coolers to be placed along the property line in the required rear yard setback would allow a more full service grocery store to serve the surrounding neighborhoods. A taller fence than normally would be allowed is at the request of the adjacent property owners and would create a better buffer between them and the coolers. The new

“Harmons” signs would identify the business but would allow the significant “Emigration Market” signs to stay. The new “Harmons” signs will not be typical Harmons’ signs, but will be aluminum freestanding lettering, 12” to 16” tall.

In addition to meeting the purpose statement of planned developments, the proposed planned development must meet one of the objectives listed in Section 21A.55.010. In particular, staff finds that the proposal meets the following standards:

- Use of design, landscape or architectural features to create a pleasing environment
- Inclusion of special development amenities that are in the interest of the general public

By bringing the building closer to the property line along 1700 East, Harmons promotes walkability to its neighbors. Allowing Harmons to use external coolers along the eastern property line will allow more square footage inside the store for the neighborhood grocery that could provide more services than the previous, smaller store. A taller fence will separate this commercial use better from surrounding residential use than the standard fence normally allowed. Allowing Harmons to construct two new, small signs will allow the significant “Emigration Market” signs to remain.

Finding: Harmons Grocery is applying for a planned development at this location because they believe it is needed to provide a full service grocery there. Staff finds that the proposed planned development meets the purpose statement of the Planned Developments chapter (21A.55.010) as it provides flexibility for the applicant to build a more walkable store and helps mitigate the commercial use to the surrounding property owners. Additionally, staff finds that the proposed planned development meets two planned development objectives by creating a pleasing environment and including development amenities that are in interest of the general public.

- B. Master Plan and Zoning Ordinance Compliance:** The proposed planned development shall be:
- a. Consistent with any adopted policy set forth in the citywide, community, and/or small area master plan and future land use map applicable to the site where the planned development will be located, and
 - b. Allowed by the zone where the planned development will be located or by another applicable provision of this title.

Analysis: A neighborhood grocery store is allowed in the site’s CN (Neighborhood Commercial) zoning district. The same zoning district is shown for that location in the East Bench Community Master Plan. The East Bench Community Master Plan states that non-residential land uses should support surrounding residential neighborhoods. The reopening of a grocery store at the subject location would be beneficial to the surrounding neighborhoods.

Finding: The proposal meets this standard.

- C. Compatibility:** The proposed planned development shall be compatible with the character of the site, adjacent properties, and existing development within the vicinity of the site where the use will be located. In determining compatibility, the Planning Commission shall consider:
- a. Where the street or other means of access to the site provide the necessary ingress/egress without materially degrading the service level on such street/access or any adjacent street/access;
 - b. Whether the planned development and its location will create unusual pedestrian or vehicle traffic patterns or volumes that would not be expected, based on:

- i. Orientation of driveways and whether they direct traffic to major or local streets, and, if directed to local streets, the impact on the safety, purpose and character of these streets;
 - ii. Parking area locations and size, and whether parking plans are likely to encourage street side parking for the planned development which will adversely impact the reasonable use of adjacent property;
 - iii. Hours of peak traffic to the proposed planned development and whether such traffic will unreasonably impair the use and enjoyment of adjacent property.
- c. Whether the internal circulation system of the proposed planned development will be designed to mitigate adverse impacts on adjacent property from motorized, non-motorized and pedestrian traffic;
 - d. Whether existing or proposed utility and public services will be adequate to support the proposed planned development at normal service levels and will be designed in a manner to avoid adverse impacts on adjacent land uses, public services and utility resources;
 - e. Whether appropriate buffering or other mitigation measures, such as, but not limited to, landscaping, setbacks, building location, sound attenuation, odor control, will be provided to protect adjacent land uses from excessive light, noise, odor and visual impacts and other unusual disturbances from trash collection, deliveries and mechanical equipment resulting from the proposed planned development; and,
 - f. Whether the intensity, size and scale of the proposed planned development is compatible with adjacent properties.

Analysis: Harmons will reopen a neighborhood grocery store that has served the surrounding community for 60 years. The planned development will keep many of the same features provided by the previous grocery store, including current non-complying structures. Harmons will add pedestrian friendly amenities such as bicycle racks and pet waiting areas when it renovates the site. It will provide an essential service to the surrounding community and it will support the surrounding single family residential uses as required in the East Bench Community Master Plan.

Primary access to the site will be via 1700 East, the existing drive will continue to be used. Commercial businesses currently operate on the other three corners of 1300 South and 1700 East. Traffic will increase on both 1300 South and 1700 East when the market reopens but it should not be a substantial increase from when the market was last in operation until spring 2010. It is not expected that the reopening of the grocery store will create unusual traffic patterns, pedestrian or otherwise.

Parking will be handled on-site: the proposed store will have 13,684 square feet, which requires 28 parking spaces (2 spaces per 1,000 square feet). Harmons has petitioned for a partial parking exemption because it is providing pedestrian friendly amenities but including bicycle racks and pet waiting areas and encouraging its employees to use alternative methods to travel to and from work. This exemption would allow Harmons to provide only 23 spaces. Harmons plans to offer 24 parking spaces. Transportation has agreed to this partial parking exemption. The proposed internal circulation will be consistent with other developments of its size. All internal traffic will enter and exit via 1700 East, which can handle the additional traffic capacity.

Peak traffic will likely be on weekends and weekday evenings and there is no reason to expect that the proposed hours of operation will create noise, light or other nuisances that would impair the use and enjoyment of neighboring properties. Public Utilities reviewed the application and noted that unused sewer connections need to be removed, but made no indication that the reopening and expansion of the grocery store would impair service levels of utilities on the block or have any adverse impact on surrounding properties.

The applicant has provided landscaping plans (Exhibit A: Proposed Site Plans) that show an addition of landscaping to the site. Harmons also plans to keep the existing in-ground landscaping on site. Harmons will also provide landscaping to its surrounding neighbors to buffer the proposed non-complying coolers and exterior wall.

Finding: Staff finds that the proposed planned development is compatible with the surrounding neighborhood after consideration of the abutting streets and means of access, the anticipated traffic patterns and intensities, its internal circulation system and parking configuration and the required utilities on site.

D. Landscaping: Existing mature vegetation on a given parcel of development shall be maintained. Additional or new landscaping shall be appropriate for the scale of the development, and shall primarily consist of drought tolerant species.

Analysis: The existing mature vegetation on site will be maintained and the site renovations will include a full landscaping plan that will add a significant number of trees and shrubbery and other landscaping elements. The landscaping is intended to buffer the use from neighboring residential properties and soften the development's impact to the neighborhood. Additionally, Harmons is placing landscaping in the abutting residential yards to lessen its impact further. It is unknown whether or not the proposed landscaping is consistent with the surrounding properties.

Finding: Staff finds that the proposed landscaping provides a significant upgrade to the site and enhances the proposed planned development. Additionally, the landscaping should provide an adequate buffer between the residential properties that surround the subject properties.

E. Preservation: The proposed planned development shall preserve any historical, architectural and environmental features of the property.

Analysis: Harmons will preserve the two unique "Emigration Market" signs on the site.

Finding: The proposed planned development meets this standard.

F. Compliance with Other Applicable Regulations: The proposed planned development shall comply with any other applicable code or ordinance requirement.

Analysis: The proposed planned development will only differ from zoning district regulations in the instances outlined in the application and discussed above: to keep and expand current non-complying structures, build a non-complying fence and construct two non-complying signs.

Finding: The proposed planned development meets this standard.

Planned Developments in the CN Zoning District are subject to Zoning Ordinance Section 21A.55.090 Specific Standards for Planned Development in Certain Zoning Districts. The standards and analysis are listed and discussed below:

Specific Standards for Planned Development in Certain Zoning District: Planned developments within the TC-75, RB, R-MU, MU, CN, CB, CSHBD South State Street corridor overlay district and CS districts may be approved subject to consideration of the following general conceptual guidelines:

- a. The development shall be primarily oriented to the street, not an interior courtyard or parking lot;
- b. The primary access shall be oriented to the pedestrian and mass transit;
- c. The façade shall maintain detailing and glass in sufficient quantities to facilitate pedestrian interest and interaction;
- d. Architectural detailing shall emphasize the pedestrian level of the building;
- e. Parking lots shall be appropriately screened and landscaped to minimize their impact on the neighborhood;
- f. Parking lot lighting shall be shielded to eliminate excessive glare or light into adjacent neighborhoods;
- g. Dumpsters and loading docks shall be appropriately screened or located within the structure; and,
- h. Signage shall emphasize the pedestrian/mass transit orientation.

Analysis: Harmons will maintain Emigration Market’s street orientation by placing outdoor seating along 1300 South and a store entrance on 1700 East, though the main store entrance will continue to face the interior parking lot. Harmons will encourage pedestrian traffic by placing four bicycle racks and two pet waiting areas along 1700 East as well as reimbursing its employees public transportation costs.

Harmons proposes to replace the glass windows along 1700 East with panels that transition from translucent glazing to transparent glass roughly 4’ 6” above the sidewalk grade. Harmons makes this request because it plans to place the bakery/deli work area along 1700 East. Staff believes the transition from translucent panels to transparent glass should occur at a lower elevation to maintain the building’s pedestrian orientation.

Harmons plans to maintain the existing in-ground landscaping that currently surrounds the grocery store’s parking lot. Also, the site renovations will include a full landscaping plan that will add a significant number of trees, shrubbery and other landscaping elements. The landscaping is intended to buffer the use from neighboring residential properties and soften the development’s impact to the neighborhood. Additionally, Harmons is placing landscaping in the abutting residential yards to lessen its impact further. Harmons will use guidelines from Dark Sky Initiative for the parking lot lights to diminish the impact on surrounding residences. The dumpster will be properly screened and located next to the existing loading dock in the parking lot. The dumpster will be separated from residences by existing mature vegetation.

Harmons will maintain the two current non-complying “Emigration Market” roof signs along 1300 South and 1700 East. Harmons also wants to add two new non-complying signs at the customer entrances to the store. The new aluminum “Harmons” signs will sit directly above the main door vestibules facing the parking lot and 1700 East. The “Harmons” signs will range in 12 to 16 inches in height above the roof line of each vestibule.

Finding: Staff finds that Harmons generally meets this standard in its planned development application but believes the standard would be further met if Harmons was required to place transparent glass beginning at 3 feet above sidewalk elevation along 1700 East to promote the building’s pedestrian orientation.

Attachment A Photographs



View from 1300 South



View from 1300 South and 1700 East



Store Entrance and Parking Lot along 1700 East



Store Parking Lot along 1700 East

PRESCOTT MUIR ARCHITECTS
171 West Pierpont Avenue
Salt Lake City, Utah 84101
801-521-9111 • 801-521-9158 fax

MEMO

DATE: November 22, 2010
(REVISED)

TO: Salt Lake City Planning Department

FROM: Kristen Voros

PROJECT: Harmons Emigration Market
1706 East 1300 South
Salt Lake City, Utah

RE: Planned Development as a Conditional Use – Project Description and Discussion

The property located at 1706 East and 1300 South in Salt Lake City was previously the Emigration Market. Harmons has recently purchased the property and would like to renovate the building and re-open the Harmons Emigration Market as a full service grocery store.

The store is located on the Southeast corner at the intersection of 1300 South and 1700 East. There are residential properties adjacent to the site on the east and south sides of the property. Across 1700 East is a pharmacy with office space above, across 1300 South is a newly constructed restaurant and kitty-corner to the site is another restaurant.

When the property was purchased Harmons became aware of two existing non-conforming structures. The first is the enclosed area on the West side of the building. When this was originally permitted by the previous owner it was permitted as a covered outdoor seating area. Sometime after the previous owner gained approval from the City this area was enclosed therefore creating a non-conforming structure. This structure sits within the required 15' front yard setback and was also built approximately 2' over the property line. Harmons is proposing to demolish this front addition because it was constructed very poorly. Harmons would like to formally gain approval to re-build this structure within the front yard setback and up to the property line in order to maximize their store floor area and to rectify the relationship of the building to the property line

The second non-conforming structure is the refrigerated walk-in cooler that is located on the East side of the building within the required 10' backyard setback. This cooler was put in place by the previous owner without approval from the City. Harmons would like to gain approval from the City to expand this cooler and provide additional refrigerated storage across the length of the East side of the building. With this additional cooler storage capacity Harmons is able to maximize the sales floor area and provide a full service grocery store. The equipment that runs these coolers will be placed on the West side of the loading dock roof in order to keep the noise associated with the roof top equipment away from the neighbor's property.

The zoning ordinance requires that a solid fence between 4 and 6 feet in height be erected along property lines adjacent to residential properties. The proposal is to provide a solid wall that consists of brick piers with concrete infill panels. Harmons has discussed the height of this wall with all of the adjacent neighbors and would like to gain approval to build this new wall at the height preferred by the adjacent property owners.

The preference of the two owners who are on the east side of the property and adjacent to the new refrigerated walk-in coolers that are being proposed is to have the wall height match the height of the refrigerated walk-in coolers to help screen them from view. The wall would be approximately 8'-0" above the neighbors finish grade. There is about a 1'-4" grade difference to the Harmons property so on the Harmons side the wall would be about 9'-4" in height. The wall will stay at 8'-0" as it runs south along the east property line until it comes to the third property owner's

property line. At this point the wall will step down to 5'-7" in height because this property owner would like the new wall to match the height of her existing fence. Then once the wall hits the south property line and starts to run west the wall height will step up to 6'-6" in height and then step down to 4'-0" in height once the wall comes to the front corner of the south property owner's house. The wall will also stop 4'-0" back from the property line as it approaches 1700 East. This is based on the preference of the property owner.

Harmons will provide the adjacent neighbors some landscape improvement in their yards to provide screening of the new wall from their property. A Landscape Architect has already met with the adjacent neighbors to discuss the landscape improvements and what types of landscaping they would prefer.

The existing building height is 18'-0" and will remain the same. The existing Emigration Market signage will be refurbished and will remain on the North and West facades. Harmons would also like to add roof signage above the 2 main entries on the West and South facades. These signs will sit above the roof line of the entry vestibule and the letters will be aluminum. Roof signs are not allowed by the zoning ordinance so Harmons would like to include this as part of the planned development as a conditional use approval. The proposed design uses the red brick of the original structure with panels of glazing and yellow stucco. The glazing on the West side of the building has been maximized to increase pedestrian interest and interaction.

The project has been discussed extensively with the neighbors adjacent to the property and their responses have been very positive. The project has also been presented to the Wasatch Hollow Community Council. The feedback was very positive and the meeting resulted in a vote to approve the requested variances. Of the people present 100% voted for the variances. The project has also been presented to the adjacent Yalecrest Community Council. The project received a very favorable response here as well.

The operating hours of the store will be Monday through Saturday from 6:00 am to 10:00 pm and Sunday from 7:00 am to 7:00 pm. Deliveries will take place in off peak hours typically from 7:00 am to 9:00 am.

There will be 24 parking stalls provided. The zoning ordinance requires 28 parking stalls. However in the zoning ordinance there is a parking exemption for pedestrian friendly development which states, "In the CN zoning district businesses may be granted a partial exemption from off street parking requirements if they satisfy the criteria set forth below. For any business that has pedestrian friendly amenities, such as bike racks, baby buggy parking areas, benches and other similar pedestrian oriented amenities, which are located with 100 feet of the entrance to the business may exclude the first 2,500 square feet of the building area from the parking calculations. With this exemption 23 parking spaces are required. As part of this development 4 bike racks will be provided along with 2 pet waiting areas on the west side of the property. The pet waiting areas will have a frame to hook leashes to as well as a replenishing water bowl.

There will be approximately 10 employees on-site at peak hours. Harmons will reimburse their employees for public transportation fees and will strongly encourage their employees to utilize public transportation, biking or walking.

There will be indoor and outdoor seating provided. There will be 27 indoor seats provided in the Southwest corner of the building as well as 28 outdoor seats provided on the North side of the building.

The proposed gross building area is 13,684 square feet.
Main gross floor area = 12,190 square feet
Basement gross floor area = 1,494 square feet

The existing gross building area is 12,849 square feet.
Main gross floor area = 11,355 square feet
Basement gross floor area = 1,494 square feet

**Attachment C
Proposed Site Plans**

1300 South Street

1700 East Street

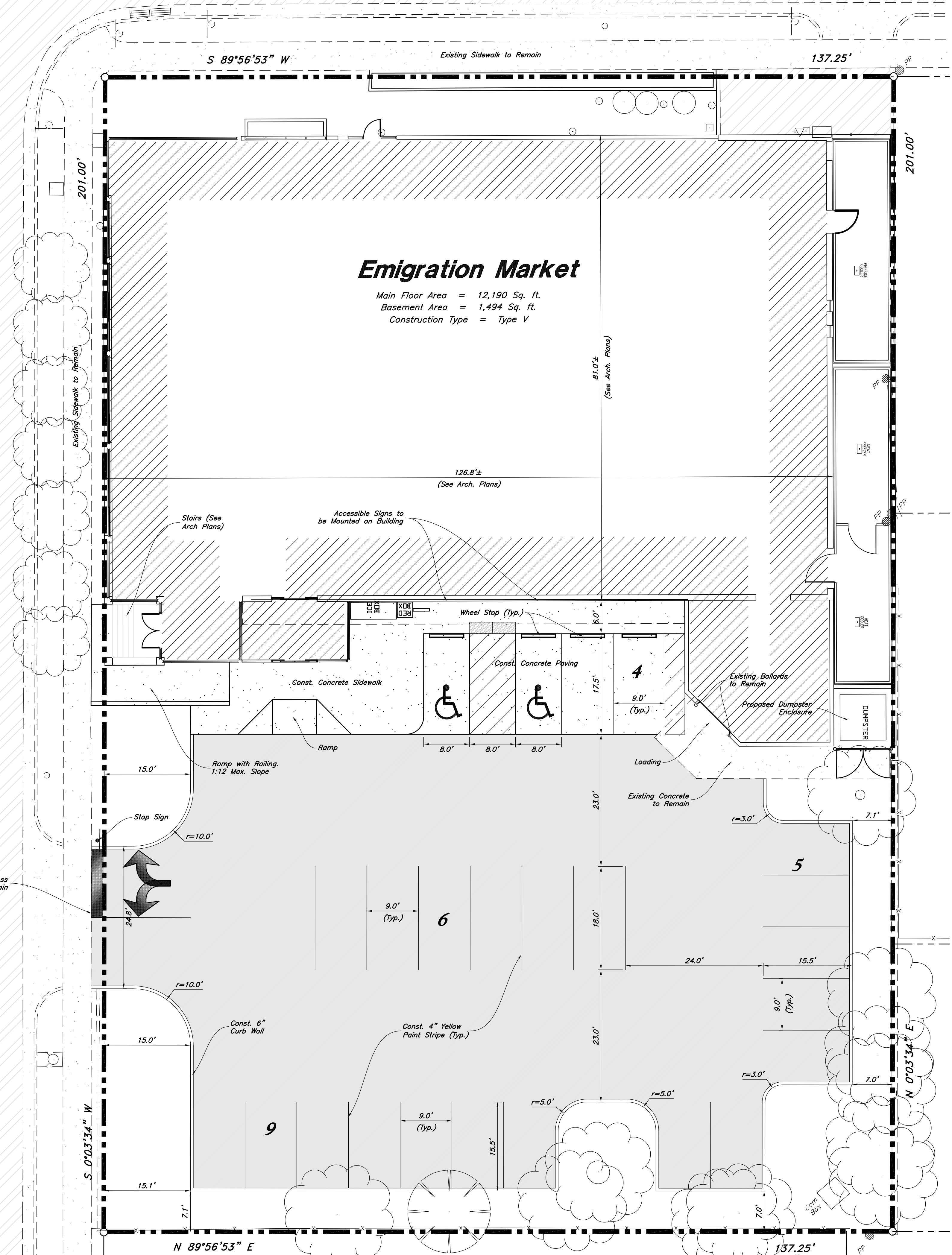

Emigration Market

Main Floor Area = 12,190 Sq. ft.
 Basement Area = 1,494 Sq. ft.
 Construction Type = Type V

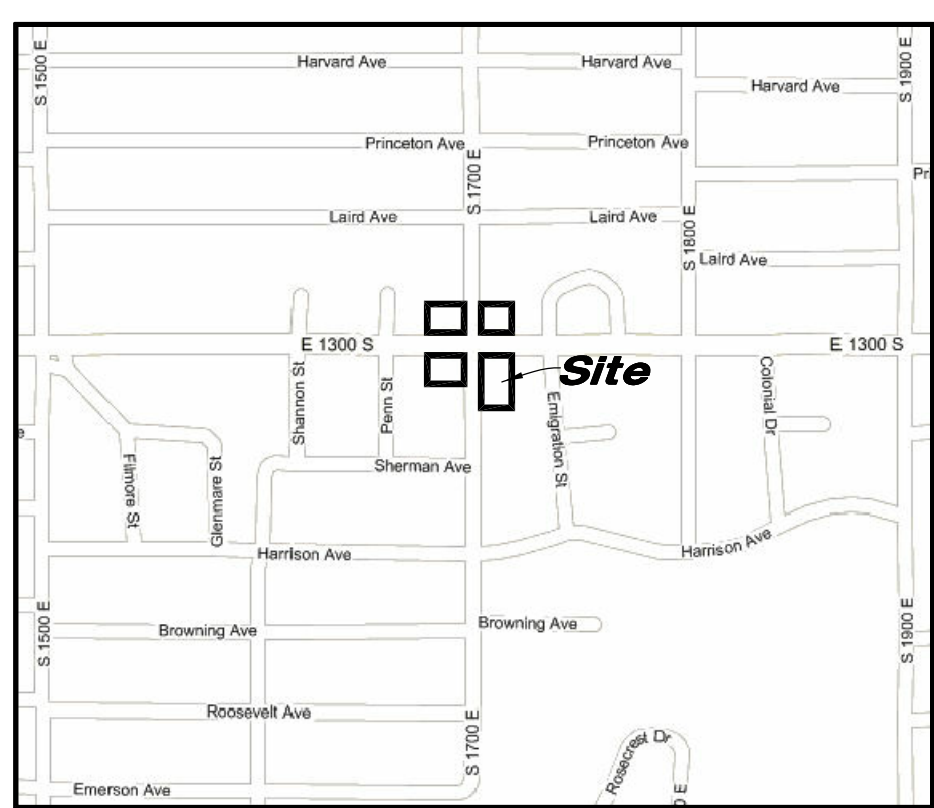

Vicinity/Zoning Map
Not to Scale

Areas Zoned CN,
 Neighborhood Commercial

All Other areas Shown are
 Zoned:
 R-1-5000, Single Family Residential
 R-1-7000, Single Family Residential
 PL, Public Lands
 I, Institutional

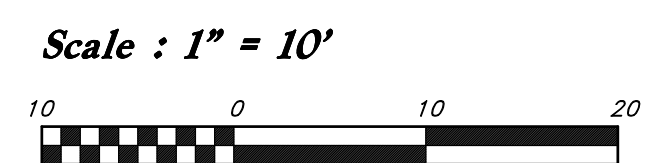
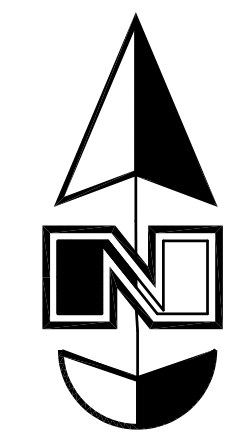

Description

Lots 1, 2, 3, 4, Block 1, Emigration Park Subdivision, according to the official plat thereof, filed in Book "1" of Plats at Page 65 of the Official Records of the Salt Lake County Recorder.

Zoning

CN, Neighborhood Commercial

Site Data Table

Site Area = 27,587 Sq. ft. (0.633 Acres)
 Building Area = See Arch Plans
 Parking Provided = 24 Stalls

General Site Notes:

1. Stalls designated as Accessible will require a painted Accessible symbol and sign. (See Details)
2. All dimensions are to back of curb unless otherwise noted.
3. Const. curb transition at all points where curb abuts sidewalk.

ADA Note:
 Contractor must maintain a running slope on Accessible routes no steeper than 5.0% (1:20). The cross slope for Accessible routes must be no steeper than 2.0% (1:50). All Accessible routes must have a minimum clear width of 36". If Grades on plans do not meet this requirement notify Consultant immediately.
 The Client, Contractor and Subcontractor should immediately notify the Consultant of any conditions of the project that they believe do not comply with the current state of the ADA (ICC/ANSI A117.1-Latest Edition) and/or F344.

Survey Control Note:
 The contractor or surveyor shall be responsible for following the National Society of Professional Surveyors (NSPS) model standards for any surveying or construction layout to be completed using Great Basin Engineering's ALTA Surveys or Great Basin Engineering's construction improvement plans. Prior to proceeding with construction staking, the surveyor shall be responsible for verifying horizontal control from the survey monuments and for verifying any additional control points shown on an ALTA survey, improvement plan, or on electronic data provided by Great Basin Engineering. The surveyor shall also use the benchmarks as shown on the plan, and verify them against no less than three existing hard improvement elevations included on these plans or on electronic data provided by Great Basin Engineering. If any discrepancies are encountered, the surveyor shall immediately notify the engineer and resolve the discrepancies before proceeding with any construction staking.

PRIVATE ENGINEER'S NOTICE TO CONTRACTORS
 The Contractor agrees that he shall assume sole and complete responsibility for job site conditions during the course of construction of this project, including safety of all persons and property; that this requirement shall apply continuously and not be limited to normal working hours; and that the contractor shall defend, indemnify, and hold the owner and the engineer harmless from any and all liability, real or alleged, in connection with the performance of work on this project, excepting for liability arising from the sole negligence of the owner or the engineer.

GREAT BASIN ENGINEERING - SOUTH
 CONSULTING ENGINEERS and LAND SURVEYORS
 2010 North Redwood Road, P.O. Box 16747
 Salt Lake City, Utah 84116
 Fax: (801)521-9551
 (801)521-8529 Open (801)394-7288

Site Plan
Emigration Market
 1706 East 1300 South
 Salt Lake City, Utah

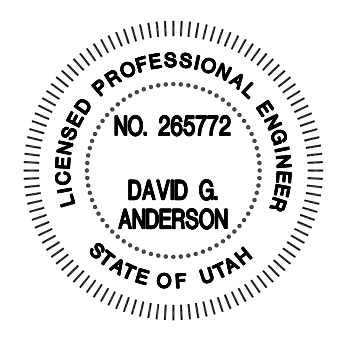

7 Oct, 2010
 SHEET NO.
C1.0

1300 South Street

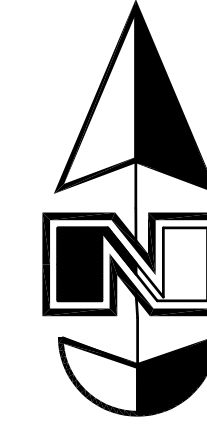

Scale : 1" = 10'



Emigration Market

Finish Floor = 07.33± (Match)

1700 East Street

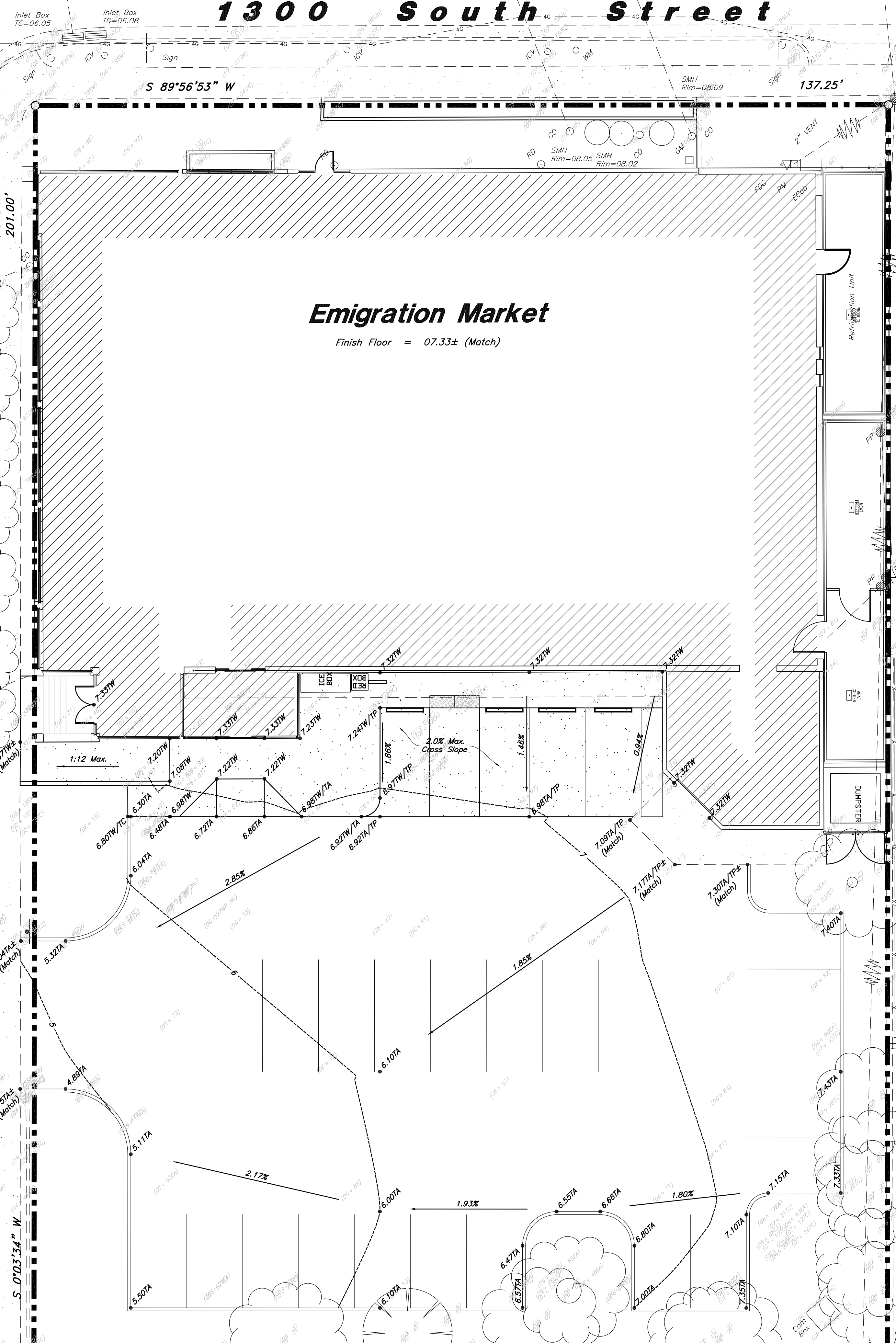

ADA Note:
 Contractor must maintain a running slope on Accessible routes no steeper than 5.0% (1:20). The cross slope for Accessible routes must be no steeper than 2.0% (1:50). All Accessible routes must have a minimum clear width of 36". If Grades on plans do not meet this requirement notify Consultant immediately.
 The Client, Contractor and Subcontractor should immediately notify the Consultant of any conditions of the project that they believe do not comply with the current state of the ADA (ICC/ANSI A117.1-Latest Edition) and/or FHAA.

REV	DATE	DESCRIPTION

Designed by: DA
 Drafted by: LC
 Client Name:
 Harmons
 10-0556R

GREAT BASIN ENGINEERING - SOUTH
 CONSULTING ENGINEERS and LAND SURVEYORS
 2010 North Redwood Road, P.O. Box 16747
 Salt Lake City, Utah 84116
 Salt Lake City, (801)551-8529 Ogden (801)394-7288 Provo (801)927-9551

Grading Plan
Emigration Market
 1706 East 1300 South
 Salt Lake City, Utah

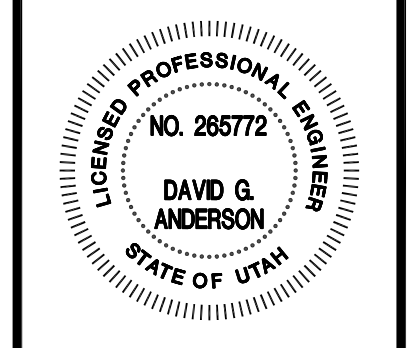

7 Oct, 2010
 SHEET NO.
C2.0

C:\kard\Draws\10-0556R.DWG, 10/7/2010, 2:46:00 PM, 11, LC

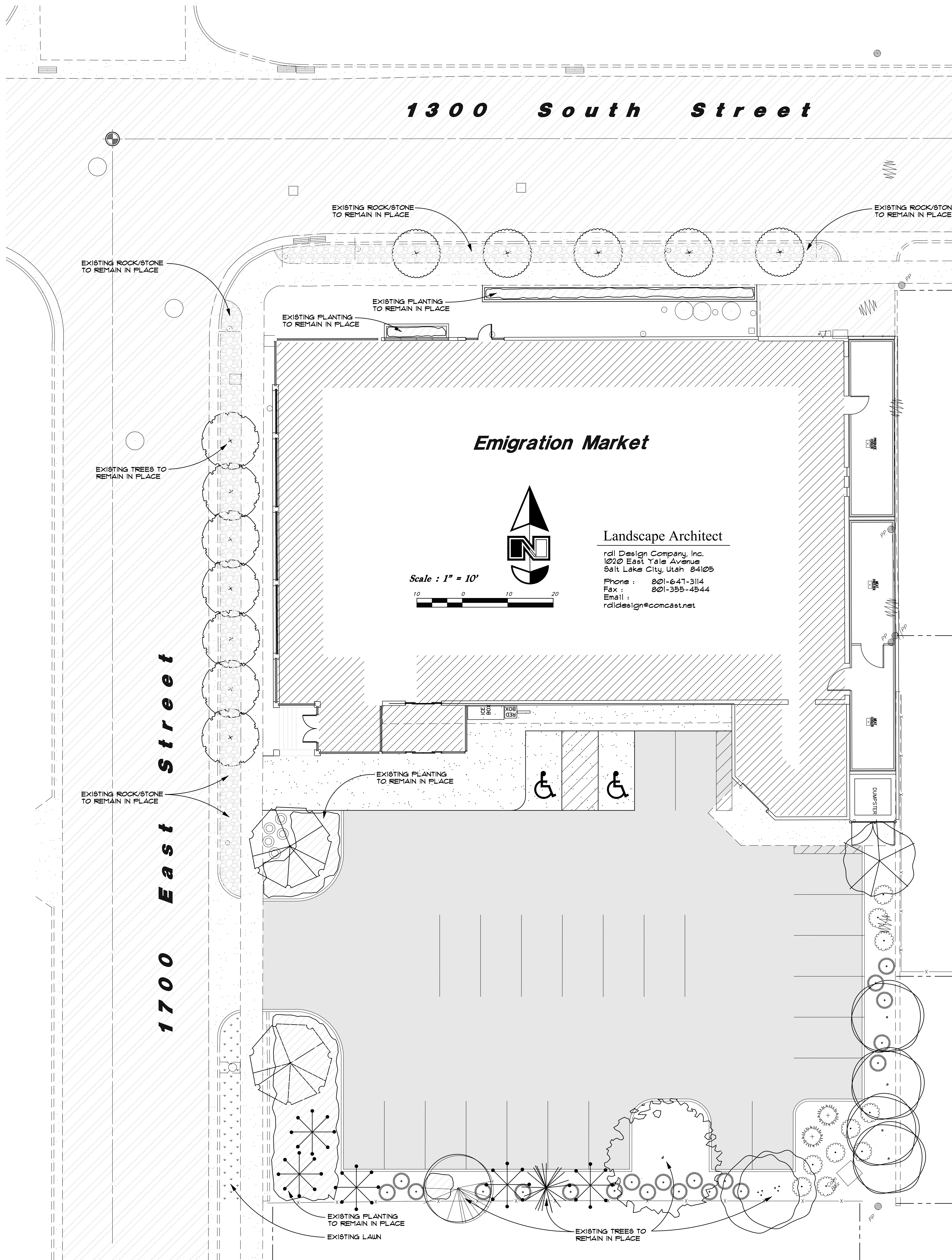

Plant List (TREES)

Quantity	Symbol	Botanical Name	Common Name	Size	Remarks
1	(Symbol)	Existing Tree (To Remain)	Hackberry	Existing	Protect / Maintain During Construction
1	(Symbol)	Existing Tree (To Remain)	Oak	Existing	Protect / Maintain During Construction
1	(Symbol)	Existing Tree (To Remain)	Horsechestnut	Existing	Protect / Maintain During Construction
5	(Symbol)	Malus species	Flowering Crab	2" Caliper	Match Variety Used N. side 1300 South
4	(Symbol)	Existing Tree (To Remain)	Alder	Existing	Protect / Maintain During Construction
6	(Symbol)	Existing Tree (To Remain)	Flowering Pear	Existing	Protect / Maintain During Construction
5	(Symbol)	Pinus flexilis	Limber Pine	6'-8' Height B 4 B/Coft.	Specimen Full Width
1	(Symbol)	Existing Tree (To Remain)	Juniper	Existing	Protect / Maintain During Construction
2	(Symbol)	Zelcova serrata 'Musashino'	Musashino Zelcova	2" Caliper 8'-10' Height	Matched Head Straight Trunk
2	(Symbol)	Existing Tree (To Remain)	Maple	Existing	Protect / Maintain During Construction

Suggested Plant List (SHRUBS)

Quantity	Symbol	Botanical Name	Common Name	Size	Remarks
NA	(Symbol)	Buxus microphylla 'Winter Gem'	Crimson Pygmy Barberry	5 Gallon	15" - 18" Height
NA	(Symbol)	Cornus alba 'Ivory Halo'	Ivory Halo Dogwood	5 Gallon	18" - 24" Height
NA	(Symbol)	Physocarpus opulifolius 'Summer Wine'	Summer Wine Ninebark	5 Gallon	18" - 24" Height
NA	(Symbol)	Rhus aromatica 'Grow Low'	Grow Low Fragrant Sumac	5 Gallon	18" - 24" Spread
NA	(Symbol)	Spiraea japonica 'Neon Flash'	Neon Flash Spiraea	5 Gallon	15" - 18" Height
NA	(Symbol)	Taxus media 'Dark Green Spreader'	Dark Green Spreading Yew	5 Gallon	18" - 24" Height

Suggested Plant List (GRASSES)

Quantity	Symbol	Botanical Name	Common Name	Size	Remarks
NA	(Symbol)	Calamagrostis a. 'Karl Foerster'	Karl Foerster Feather Grass	5 Gallon	24" - 30" Height
NA	(Symbol)	Festuca ovina 'Boulder Blue'	Boulder Blue Fescue	2 Gallon	12" - 15" Height
NA	(Symbol)	Miscanthus sinensis 'Morning Light'	Morning Light Maiden Grass	5 Gallon	18" - 24" Height
NA	(Symbol)	Panicum virgatum 'Shenandoah'	Shenandoah Switchgrass	5 Gallon	18" - 24" Height
NA	(Symbol)	Fernisetum alopecuroides 'Hamel'	Hamel Dwarf Fountain Grass	2 Gallon	12" - 15" Height

Planting Notes

- All lawn areas shall receive a 4 inch depth of topsoil, all shrub planting areas shall receive an 8 inch depth of topsoil. Topsoil material is not available at the site and must be imported from an approved local source. All topsoil shall be of a sandy loam mix.
- All lawn areas shall be sodded using high grade material of a water conservative mixture, and shall be composed of turf type "Tall Fescue". Prior to installation, all areas shall receive a starter fertilizer applied at the rate recommended by the manufacturer.
- All plant material holes shall be dug twice the diameter of the rootball and 6 inches deeper. Excavated material shall be removed from the site.
- Plant backfill mixture shall be composed of 3 parts topsoil to 1 part humus additive, and shall be rotary mixed on-site prior to installation.
- Plant fertilizer shall be 'Agriform' brand 21 gram tablets used as per manufacturers recommendations.
- All trees located in lawn areas shall receive an 'Arbor Guard' trunk protector, or equal, and have a 30 inch sod-free ring.
- Upon completion of planting operations, all shrub 'pits' and tree 'wells' and planting areas shall receive a 4 inch depth of shredded bark mulch cover. The actual planting beds shall receive a 4 inch depth of decorative stone to match any material previously used on the site. All stone shall be placed over 'Dewitt' brand 30 mil woven fabric barrier. The fabric shall be cut and removed around all shrubs and trees to the edge of the water well, then add the bark mulch.
- Landscape maintenance shall be required for a period through the second mowing of the lawn (30 days min.) and shall include mowing, weeding, pruning and one fertilization.
- The project shall be swept clean of dirt and debris prior to completion of the project, and on a daily basis, if required, as determined by the Owner/contractor.
- The contractor shall comply with all warranties and guarantees set forth by the Owner, and in no case shall that period be less than one year following the date of completion and acceptance.

General Notes

- The contractor shall verify the exact location of all existing and proposed utilities, and all site conditions prior to beginning work. The contractor shall coordinate his work with the project manager and all other contractors working on the site.
- The finish grade of all planting areas shall be smooth, even and consistent, free of any humps, depressions or other grading irregularities. The finish grade of all landscape areas shall be graded consistently 1/2" below all walks, curbs, etc.
- The contractor shall stake the location of all plants for approval prior to planting. Trees shall be located equidistant from all surrounding plant material. Shrubs and groundcovers shall be triangular and equally spaced.
- The contractor shall provide all materials, labor and equipment required for the proper completion of all landscape work as specified and shown on the drawings.
- All plant materials shall be approved prior to planting. The Owner/Landscape Architect has the right to reject any and all plant material not conforming to the specifications.
- The contractor shall plant all plants per the planting details, stake/guy as shown. The top of the root balls shall be planted flush with the finish grade.

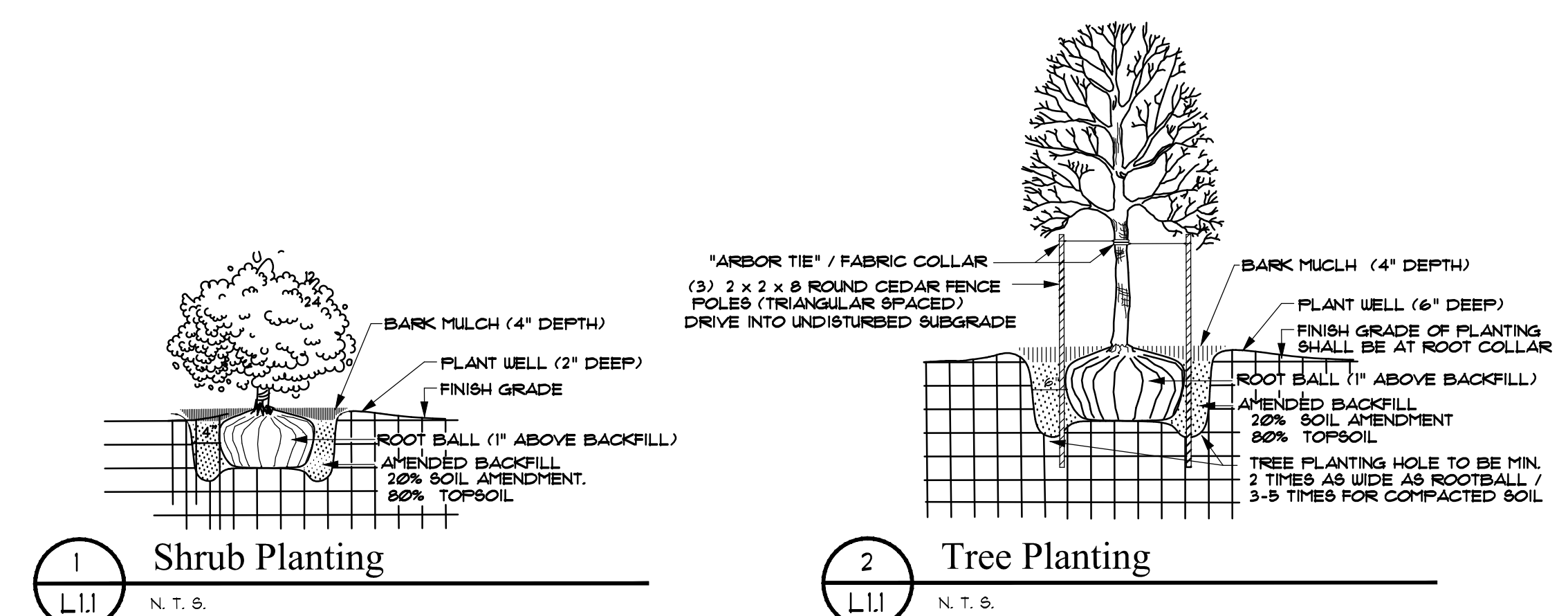

GREAT BASIN ENGINEERING - SOUTH
 CONSULTING ENGINEERS and LAND SURVEYORS
 2010 North Redwood Road, P.O. Box 16747
 Salt Lake City, Utah 84116
 Phone: (801)351-8529 Office: (801)394-7288 Fax: (801)351-8551

Preliminary Landscape Plan
Emigration Market
 1706 East 1300 South
 Salt Lake City, Utah

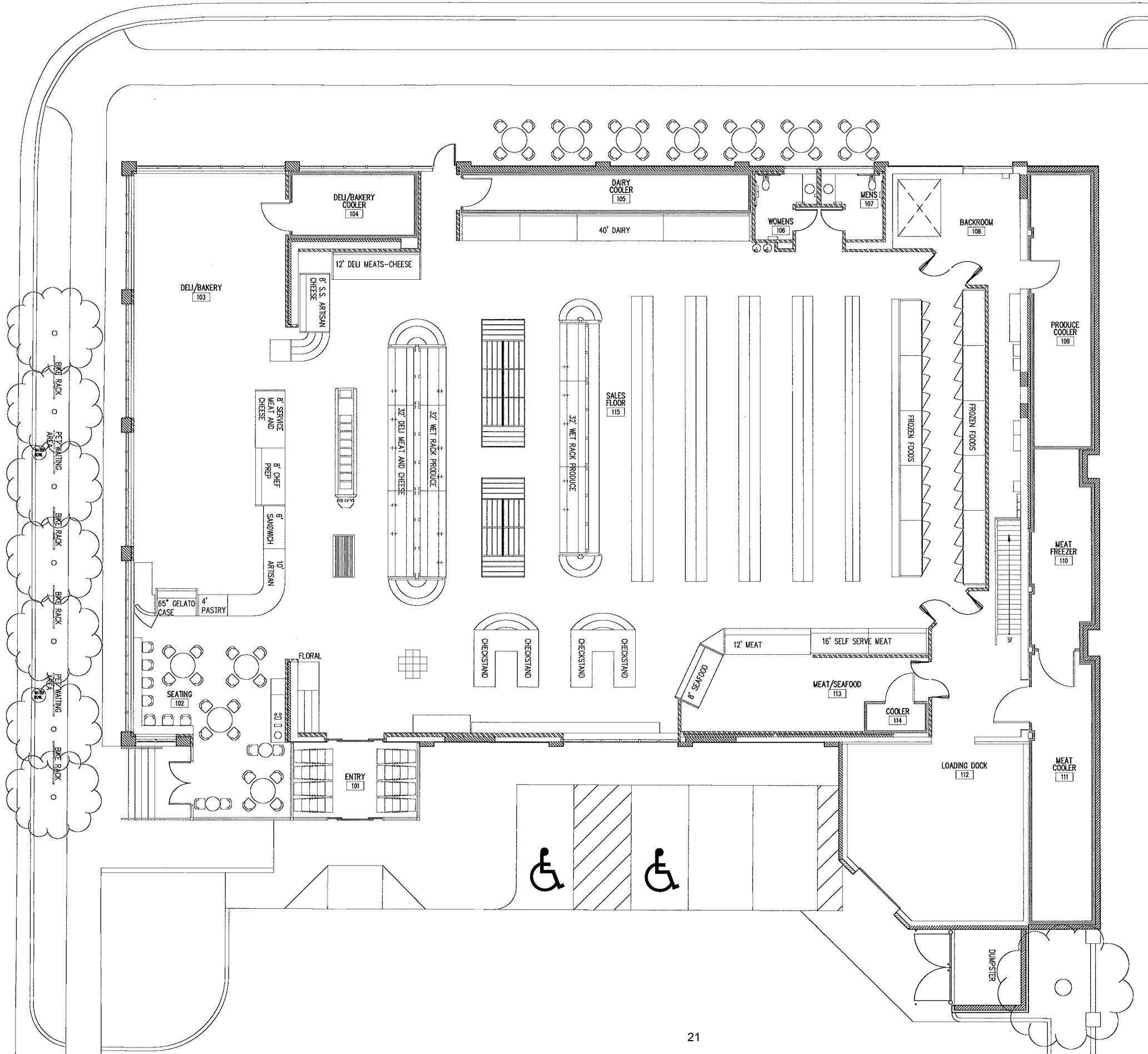

BUILDING INFORMATION
ZONE = CN

EXISTING BUILDING FOOTPRINT = 11,141 SF
EXISTING ACCESSORY STRUCTURE = 214 SF
TOTAL AREA = 11,355 SF

PROPOSED BUILDING FOOTPRINT = 11,423 SF
PROPOSED ACCESSORY STRUCTURE = 767 SF
TOTAL AREA = 12,190 SF

SETBACKS:
FRONT SETBACK - REQUIRED = 15' PROPOSED = 0'
BACK SETBACK - REQUIRED = 10' PROPOSED = 0'

LANDSCAPE BUFFERS - REQUIRED = 7' PROPOSED = 7'

FLOOR PLAN  16' ^

HARMONS EMIGRATION MARKET
PRESCOTT MUIR ARCHITECTS

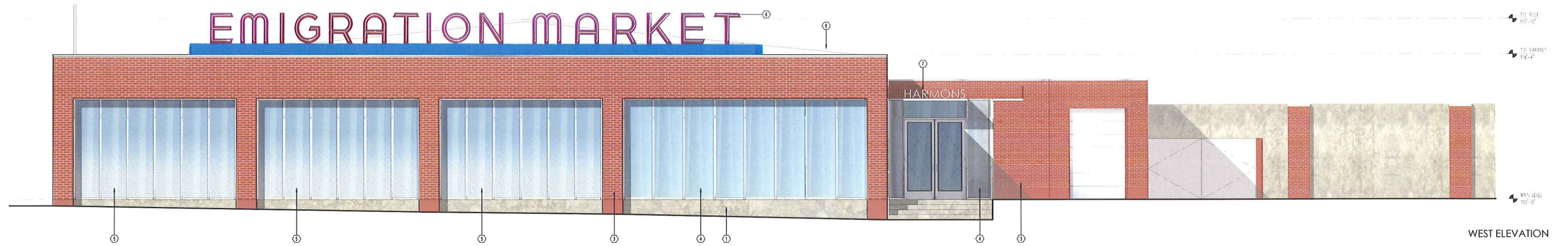

WEST ELEVATION

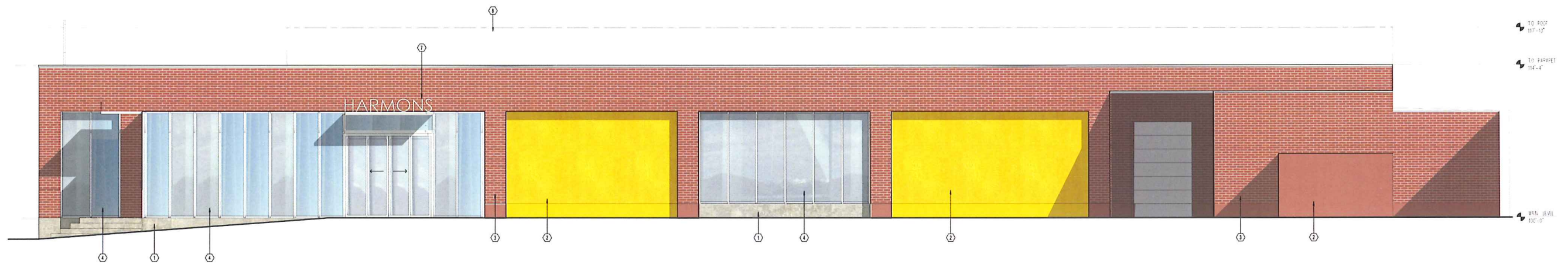

SOUTH ELEVATION

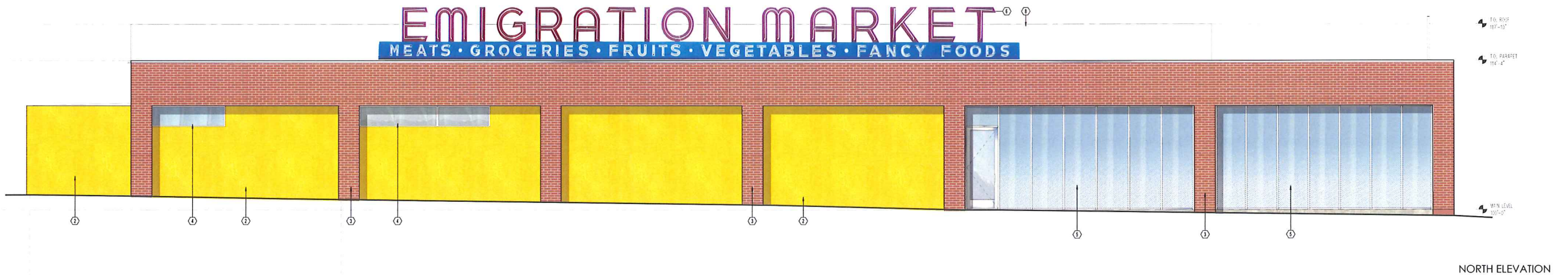

NORTH ELEVATION

MATERIALS

- 1 ARCHITECTURAL CONCRETE
- 2 EXTERIOR INSULATION FINISH SYSTEM (EIFS)
- 3 BRICK VENEER
- 4 ALUM. STOREFRONT WITH CLEAR GLAZING
- 5 ALUM STOREFRONT WITH ACID ETCHED GLAZING (GRADIENT FROM TRANSLUCENT TO CLEAR)
- 6 EXISTING SIGNAGE TO REMAIN
- 7 NEW ALUMINUM SIGNAGE
- 8 EXISTING ROOF STRUCTURE BEYOND

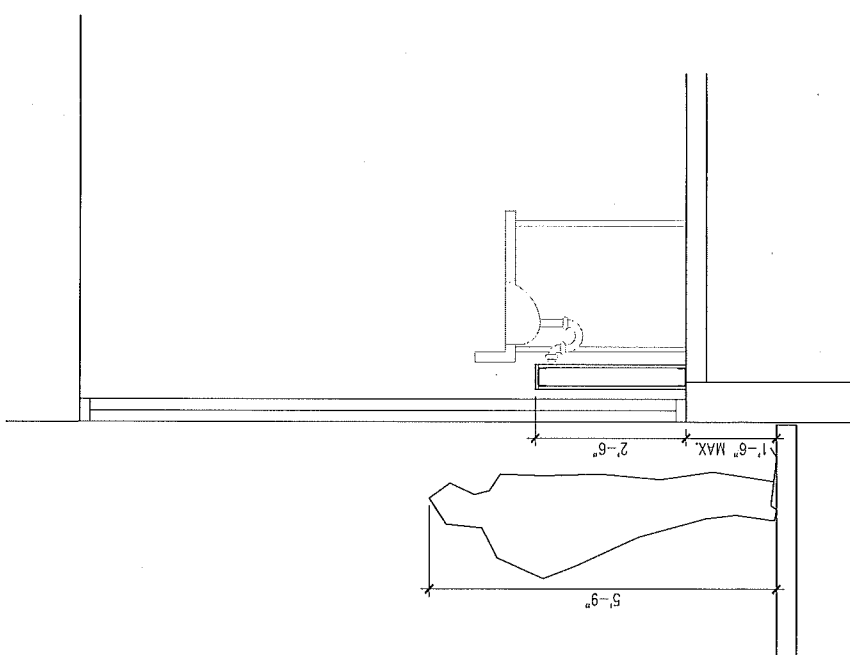
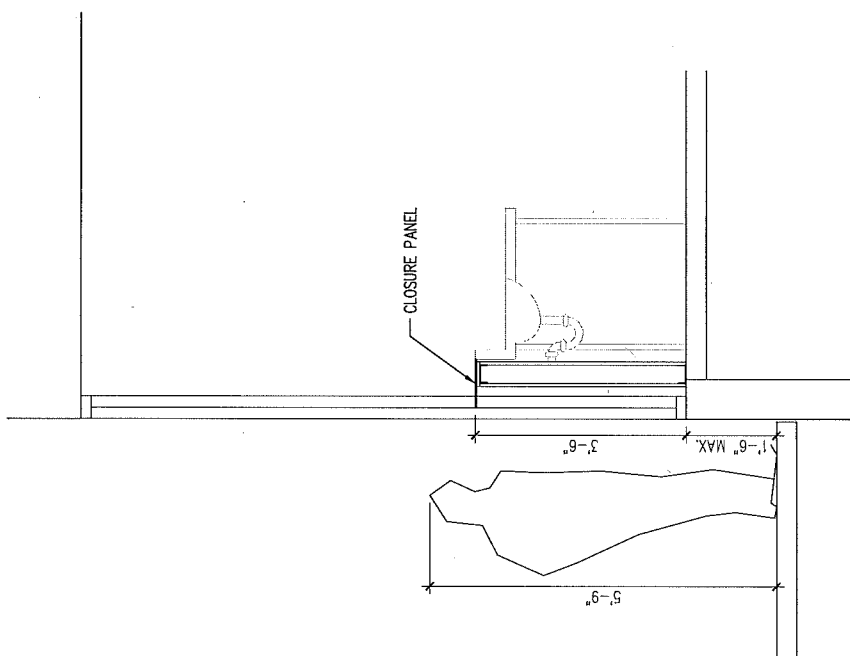

DATE: 11.23.10	SECTION AT WEST WINDOWS	P M A
SCALE: 1/2" = 1'-0"	HARMONS EMIGRATION MARKET	171 WEST
	1706 EAST 1300 SOUTH	PIERPONT AVE.
	SALT LAKE CITY, UTAH	SALT LAKE CITY
		UTAH 84101
		PH: 521-9111
		FX: 521-9158
		ARCHITECT